

Lecture 2

Basic Communication Paradigms
and Mobile Telecommunications
Infrastructures

Mobile Business I (WS 2019/20)

Prof. Dr. Kai Rannenberg

Chair of Mobile Business & Multilateral Security
Johann Wolfgang Goethe University Frankfurt a. M.

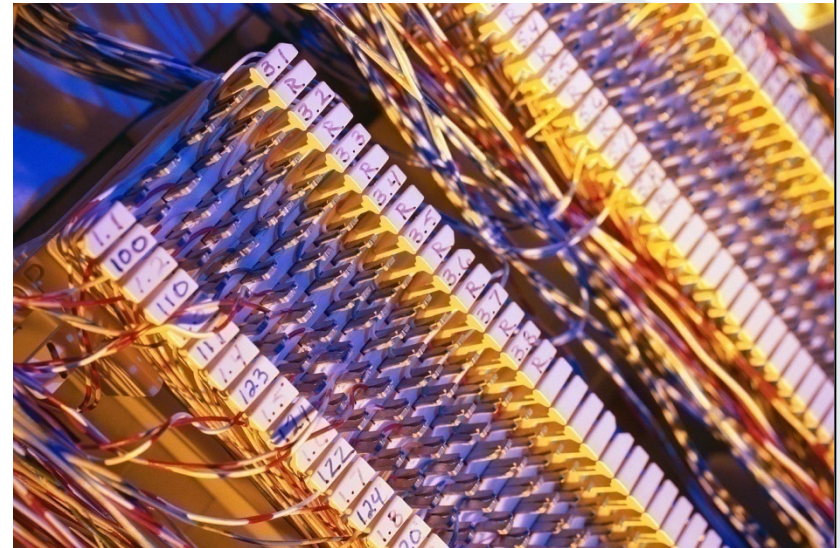

- Transmission Paradigms
- Cell Based Communication (CBC)
 - Introduction
 - Basic Technology (Cells, Multiplexing)
- Mobile Telecommunication Infrastructures
 - Introduction
 - GSM (Technology, Authentication, Location Management) (2G)
 - UMTS (3G)
 - Long Term Evolution (3.9G, 4G)
 - 5th Generation (5G): mobile broadband
- Roaming

There are two major paradigms for data transmission in communication networks:

▪ **Circuit-Switched:** In circuit-switched networks, the communication line is used exclusively for the communicating parties.

- Connections are **exclusive** ➔ even if no data is transferred, the network resources are used.
- In reality, the typical usage for voice connections is 30% of the network's capacity - for data transmission it is less than 10%.
- The **duration of a connection** is used for billing purposes
- Example: *Circuit Switched Data (CSD)* and *High-Speed Circuit Switched Data (HSCSD)* for Mobile Data Services

▪ **Packet-Oriented:** In packet-oriented networks, the communication is divided into several packets, which get addressed and transferred using a **shared** transmission medium.

- The connection is kept all the time (always on). However, the network is only used when data is transmitted.
- The capacity of the communication network is allocated dynamically.
- For billing purposes, the **amount of transferred data** is used.
- Example: GPRS for Mobile Data Services

Mobile Data Services Circuit-Switched Networks

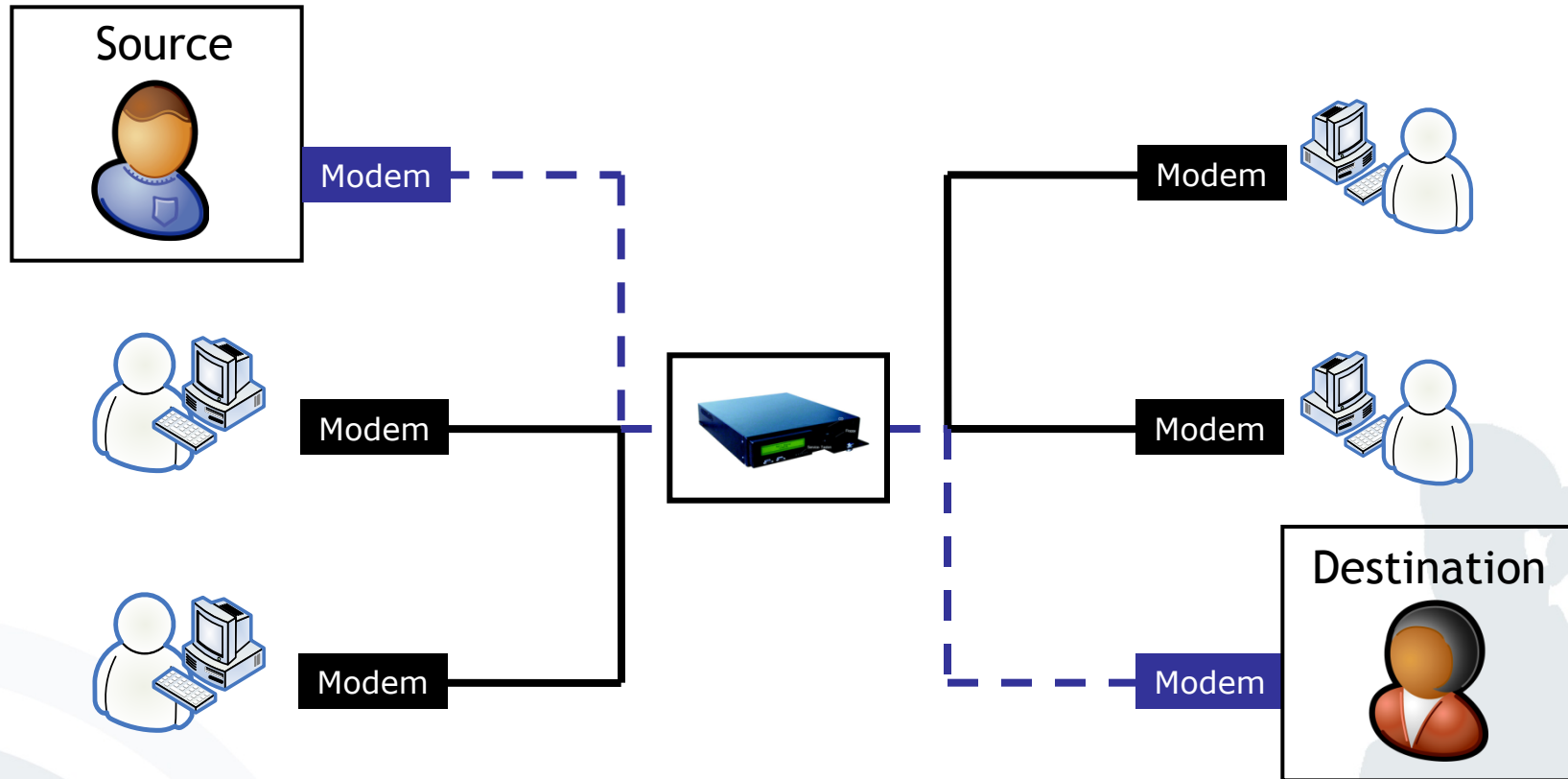

In circuit-switched networks, the communication line is used exclusively for the communicating parties (similar to the phone system, CSD and HSCSD).

[M-Chair]

Mobile Data Services Packet-Oriented Networks

In packet-oriented networks, the communication is divided into several packets, which get addressed and transferred using a shared transmission medium (e.g. the Internet).

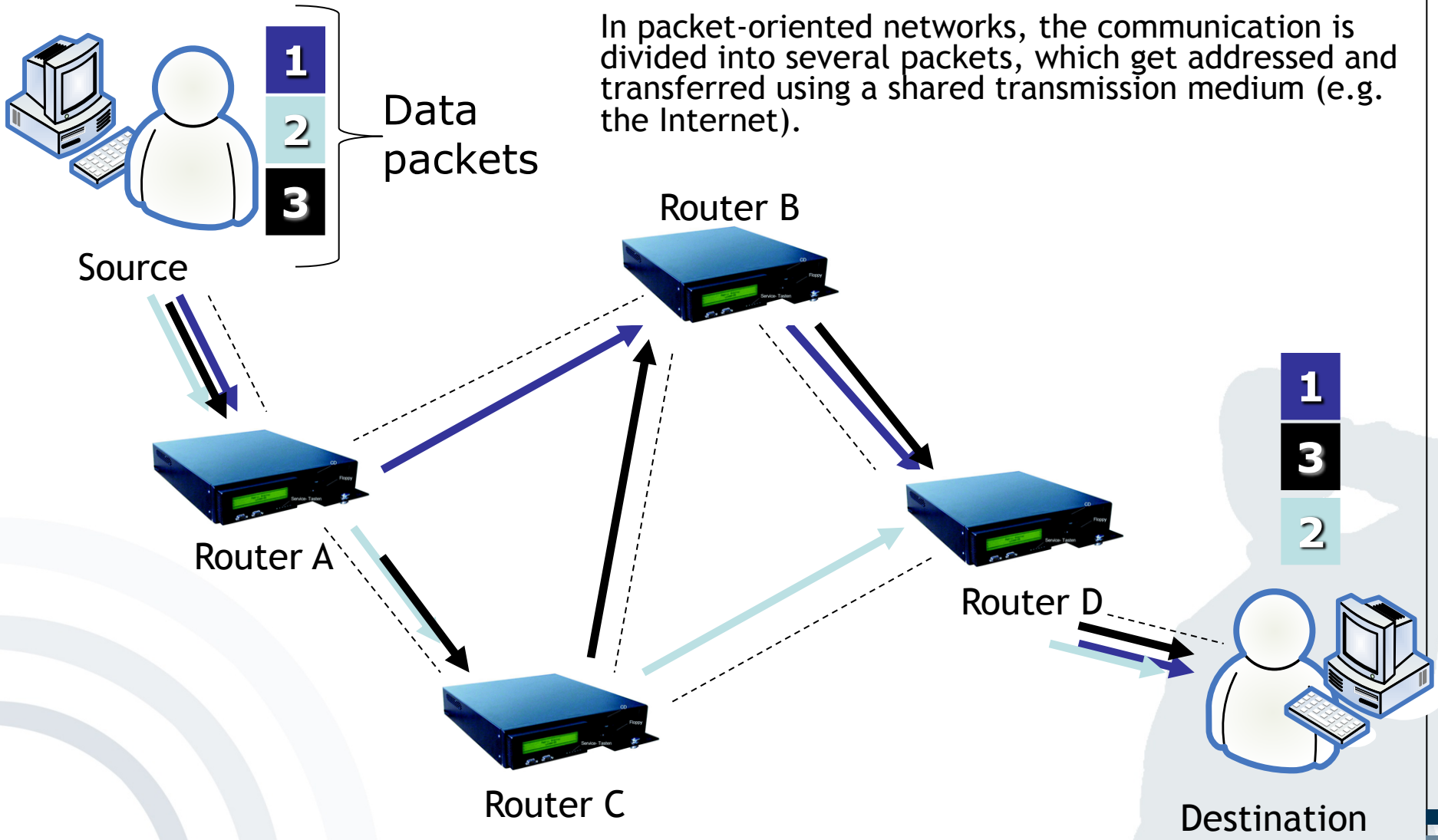

Destination

- Transmission Paradigms
- Cell Based Communication (CBC)
 - Introduction
 - Basic Technology (Cells, Multiplexing)
- Mobile Telecommunication Infrastructures
 - Introduction
 - GSM (Technology, Authentication, Location Management) (2G)
 - UMTS (3G)
 - Long Term Evolution (3.9G, 4G)
 - 5th Generation (5G): mobile broadband
- Roaming

- Cellular networks are radio networks consisting of several transmitters.
- Each transmitter or base station, covers a certain area ➔ **a cell**.
- Cell radii can vary from tens of meters to several kilometres.
- The shape of a cell is influenced by the environment (buildings, etc) and usually neither hexagonal nor a perfect circle, even though this is the usual way of drawing them.

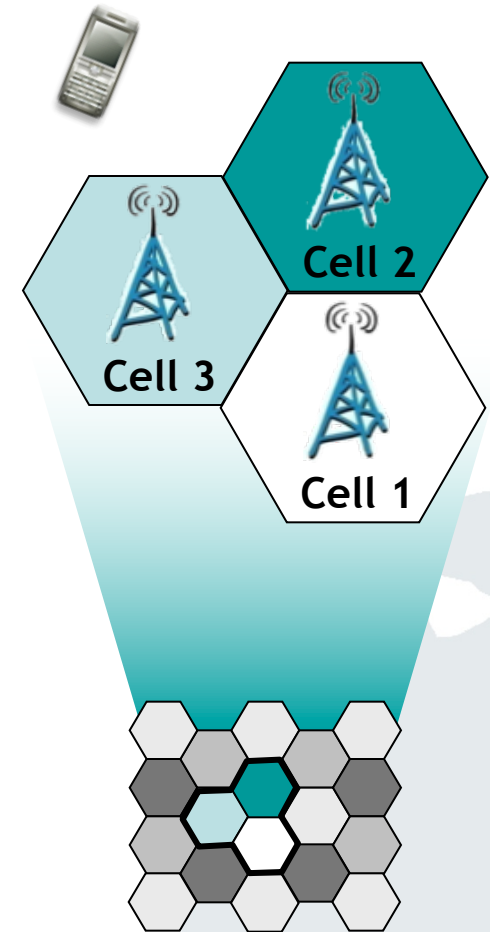

- Cellular networks offer a number of advantages compared to centralised radio systems:
 - **Higher capacity:** Cells offer the possibility to “reuse” the transmission frequencies assigned to mobile devices (e.g. by multiplexing). In order to do so, the networks need a thorough planning of the position of base stations and their frequencies.
 - ➔ More users can use the infrastructure
 - **Reduced transmission power:** Reduced power usage for the mobile device, due to the fact that only a limited amount of transmission power is needed in a small cell, compared to a far away base station.
 - ➔ Reduced power consumption for mobile devices

- Cellular networks offer a number of advantages compared to centralised radio systems:
 - **Robustness:** Cellular systems are decentralised with regard to their base stations. In the case that one antenna fails, only a small area gets affected.
 - ➔ Failure of one base station does not affect the complete infrastructure
 - **Better coverage:** Cells can be adapted to geographic conditions (mountains, buildings, etc.).
 - ➔ Better availability of the infrastructure

- However, there are also some drawbacks of cell based communication infrastructures:
 - **Required infrastructure:** A complex and costly infrastructure is required, in order to link all base stations. This includes switches, antennas, location registers, etc.
 - **Handover needed:** When changing from one cell to another, a handover mechanism is needed that allows a change of cells in real-time. These mechanisms are complex.
 - **Frequency planning:** The distribution of the frequencies being used for the base stations needs to be planned carefully, in order to minimise interferences, etc.

- Fundamental mechanism in communication system
- Describes how several users can share a medium (e.g. mobile network) with minimum or no interference.
- **Goal:** Most efficient usage of a medium
- **Abstract example:** Traffic (users) using a highway with several lanes (medium) without accidents (interference)

Frequency range of instruments of entertainment and communication electronics

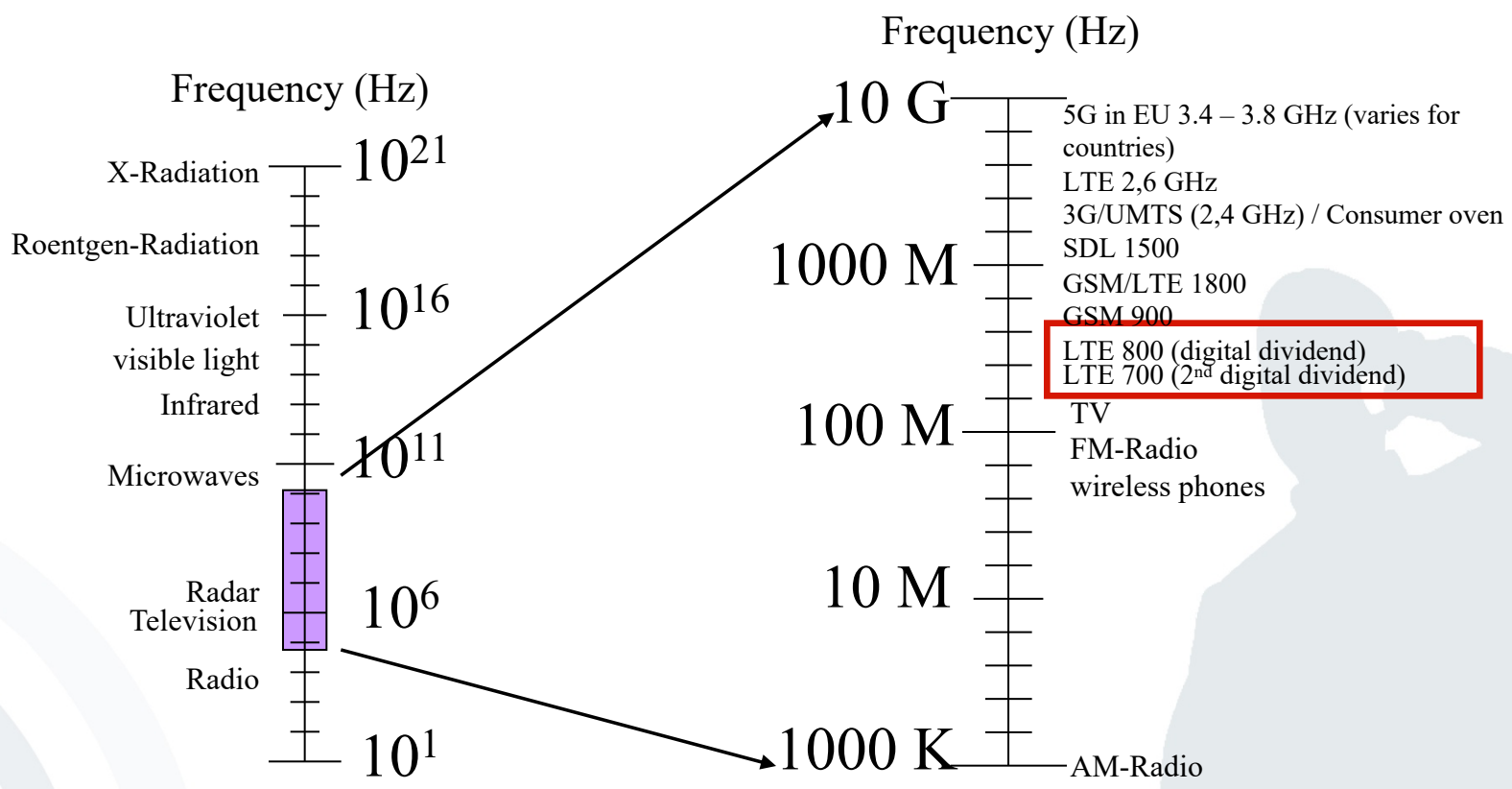

- Transmission Paradigms
- Cell Based Communication (CBC)
 - Introduction
 - Basic Technology (Cells, Multiplexing)
- Mobile Telecommunication Infrastructures
 - Introduction
 - GSM (Technology, Authentication, Location Management) (2G)
 - UMTS (3G)
 - Long Term Evolution (3.9G, 4G)
 - 5th Generation (5G): mobile broadband
- Roaming

- **1st Generation (1G) - Analogue networks**
- **2nd Generation (2G) - GSM networks**
Global System for Mobile Communications
- **3rd Generation (3G/3.5G) - UMTS/HSPA/HSPA+**
Universal Mobile Telecommunications System
High Speed Packet Access / Evolved HSPA = HSPA+
- **3.9G or 4G - LTE**
Long Term Evolution
- **4th Generation (4G) - LTE Advanced**
- **5th Generation (5G) - Mobile broadband**

Evolution of mobile telecommunication infrastructures



2G – GSM

3.9G/4G – LTE

1G

3G – UMTS

4G – LTE Advanced

5G

- **1st mobile radio network in Germany: “A-Netz”**
 - Started in 1958 - decommissioned in 1977
 - Analogue transmission
 - Manual switching of calls
 - For a call to a mobile callee the caller or operator (switchboard clerk) needed to know the location area of the callee (range from 30 to 50 km radius).
 - Frequency range 150 MHz
 - Price of terminal: 8.000 - 15.000 DM
- **2nd mobile radio network in Germany: “B-Netz”**
 - Started in 1972 – decommissioned 1994-12-31
 - Analogue transmission
 - Automatic dial switching by area code
 - Caller needed to know the area and the area code of the mobile callee.
 - Terminal prices comparable to those of the “A-Netz”

- ***3rd mobile radio network in Germany: “C-Netz”***
 - Started in 1985 – decommissioned 2000-12-31
 - Analogue transmission
 - First ***cell based*** mobile radio system in Germany
 - The change of cells happens automatically by distance measuring to the nearest base station.
 - The network can automatically detect the place of the call partner by use of a Home Location Register (HLR)
 - Uniform (location independent) area code “0161” for all participants
 - Telephone number is not allocated to the terminal but to a magnet stripe card and later a chip card (predecessor of the GSM SIM)
 - Customer peak 1993: 850.000 participants

- In 1991, the first GSM (2G) network (“D-Netze”) started in a test run in Germany.
- By introducing the worldwide GSM-standards and roaming agreements among mobile operators cross-border mobile communication became possible.
- In 2003 the first *UMTS* (3G) networks became available.

- First **Long Term Evolution Networks (3.9G/4G)** became **commercially available** in Stockholm and Oslo in 2009.
- On April and May 2010, the **digital dividend** frequency spectrum auctioned in Germany (4.4 bn €) for
 - use in Long Term Evolution Networks (3.9G/4G)
 - improving broadband coverage
- In 2012, the European Commission committed 50 m € for research to deliver **5G in 2020**.
- The radio frequencies for mobile broadband connection were auctioned in Germany (5.08 bn €) in May/June 2015.

- 5G Auction finished on June 12, 2019
- 497 auctioning rounds led to 6,55 billion Euro in bidding¹
 - Telekom: 13 frequency blocks, i.e. largest share among the bidding parties for 2,175 bn Euro
 - Vodafone: eleven frequency blocks for 1,880 bn euro
 - Telefónica: nine frequency blocks for 1,425 bn Euro
 - 1&1 Drillisch: seven frequency blocks for 1,070 bn Euro
- High bandwidth, low latency (especially important for real-time communication between devices like cars), high number of devices can be connected (IoT), availability and implementation (possible to build individual 5G networks for one company → examples include BASF and Hamburg Port)

Unique users of GSM and related networks

Recent development

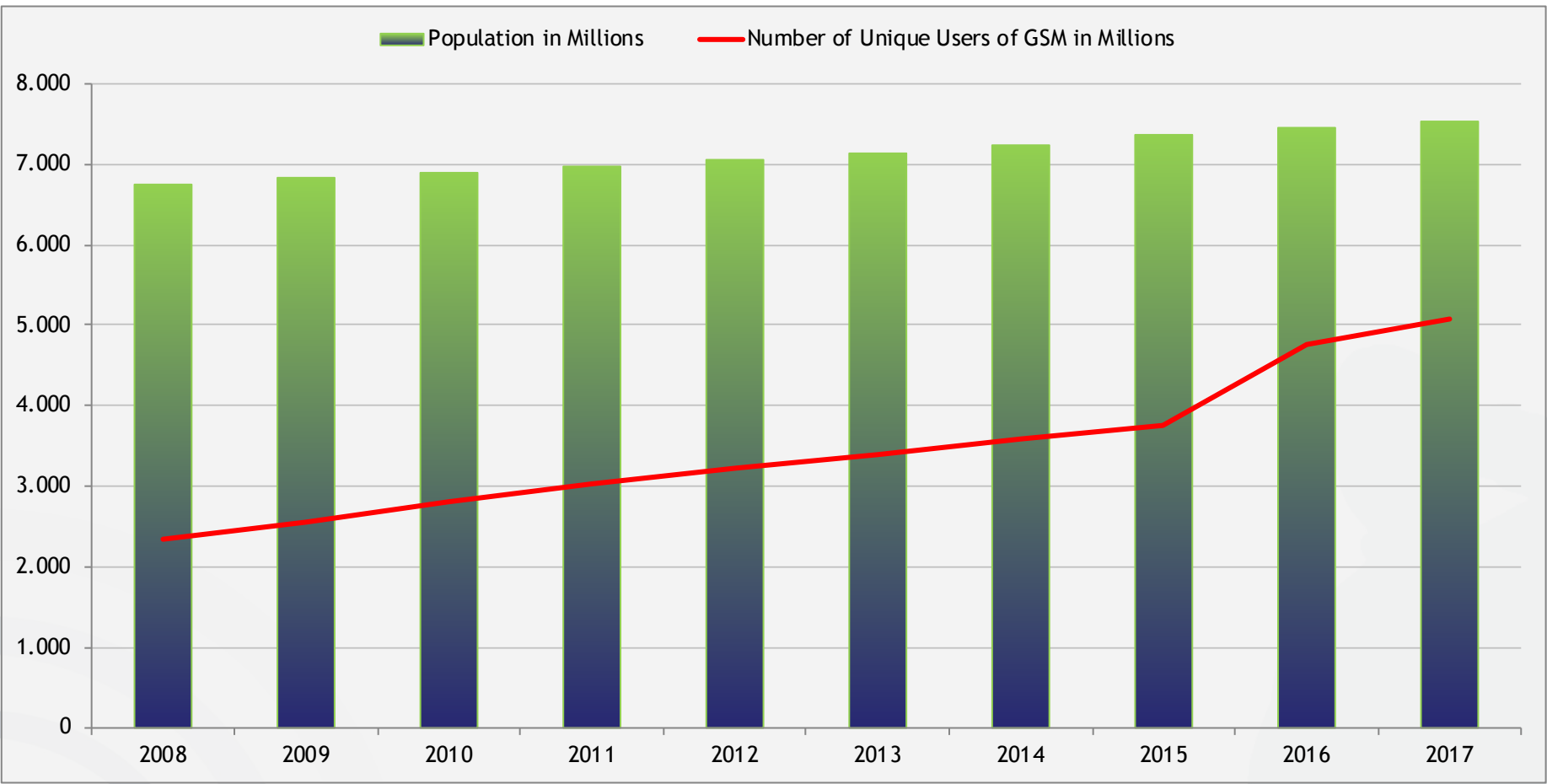

[Stat2013], [Stat2014], [StiftWelt2013], [StiftWelt2014], [GSMA2014][GSMA2015][Stat2015] [Stat2017] [GSMA2017]

- Transmission Paradigms
- Cell Based Communication (CBC)
 - Introduction
 - Basic Technology (Cells, Multiplexing)
- Mobile Telecommunication Infrastructures
 - Introduction
 - GSM (Technology, Authentication, Location Management) (2G)
 - UMTS (3G)
 - Long Term Evolution (3.9G, 4G)
 - 5th Generation (5G): mobile broadband
- Roaming

- Abbreviation for **Global System for Mobile Communications (GSM)**



- Originally 1982 driven by “*Groupe Spéciale Mobile*” in order to create a cross national standard contrary to national analogue standards

- European standard by *ETSI* (European Telecommunications Standardisation Institute). ETSI is a partner in the 3rd Generation Partnership Project (3GPP).



- Worldwide adoption of the standard in more than *212 countries and territories* (most successful mobile radio system up to now)
- Thus, worldwide roaming among different mobile network operators became possible.

■ GSM-Services

■ Carrier services

- Services to transfer signals over the GSM network
→The focus of GSM standardization was on voice services

■ Telecommunications services

- Telecommunication services (mainly voice) support the mobile communications among users
→Telecommunication services play a central role in the GSM standard

■ Supplementary services

- GSM provides a number of supplementary services (specific to network operators), such as caller ID, call redirect, closed user groups (e.g. company-internal network or GSM-R), Teleconference (up to 7 participants).

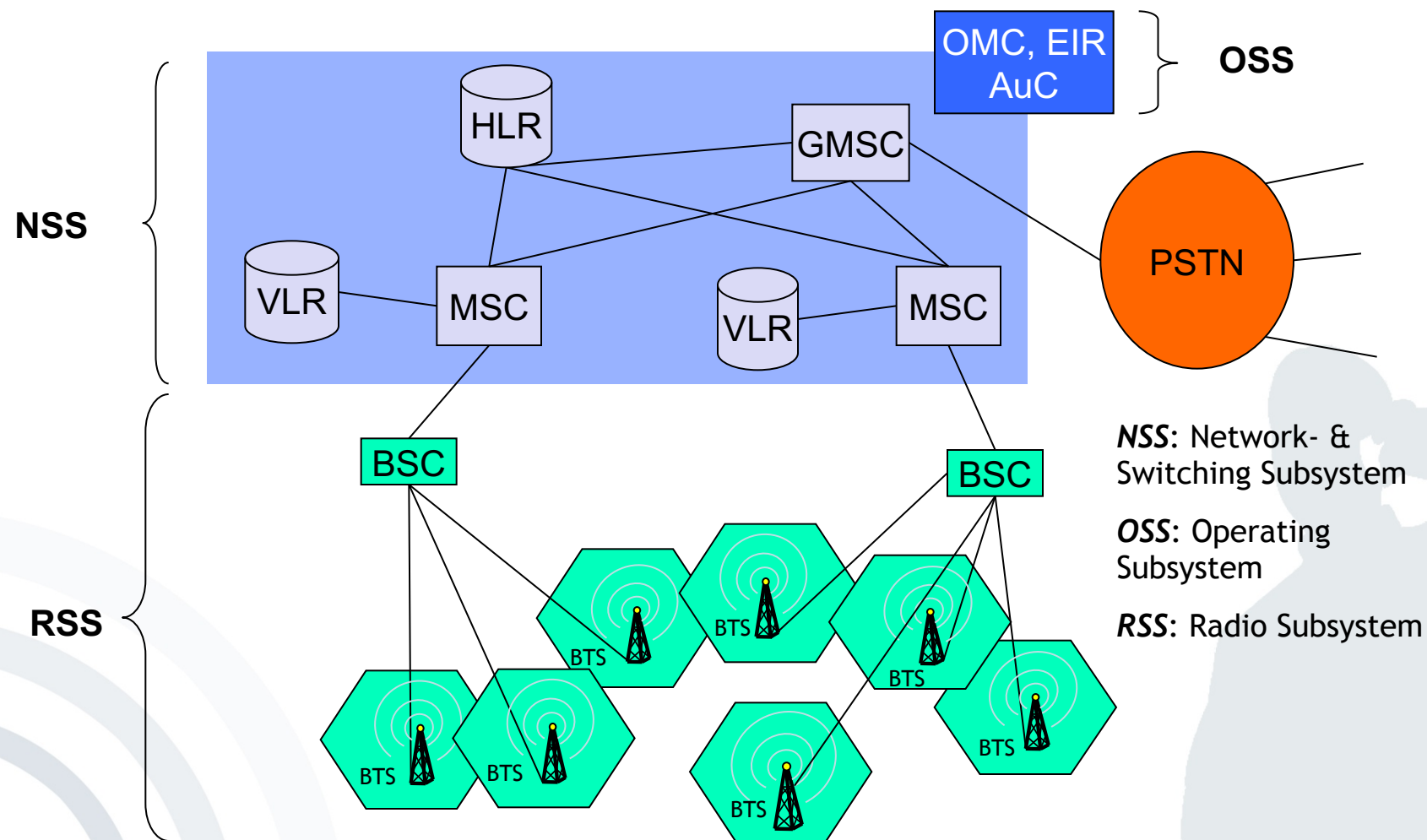

NSS: Network- & Switching Subsystem

OSS: Operating Subsystem

RSS: Radio Subsystem

Based on [Schiller2003]

- **Radio Subsystem (RSS)**
 - System consisting of radio
 - Specific components

- **Components:**

- **Mobile Station (MS):** System of mobile terminal & SIM
- **Base Transceiver Station (BTS):** Radio facility for signal transfer. A BTS serves one GSM cell (~100m to ~30km radius).
- **Base Station Controller (BSC):** Administrates affiliated BTS and supervises e.g. frequency allocation and connection handover between cells.

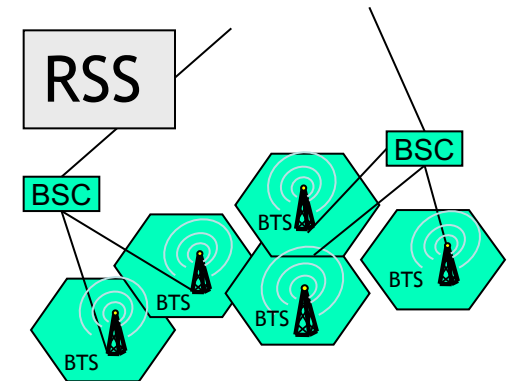

- **Network & Switching Subsystem (NSS)**

- Connects radio network with conventional networks
- Locates subscribers and monitors change of location

- **Components:**

- **Mobile Switching Centre (MSC):** Switching centre for initiation, termination and handover of connections
- **Home Location Register (HLR):** Central data base with subscribers' data (telephone numbers, keys, locations)
- **Visitor Location Register (VLR):** Data base assigned to every MSC with data of active subscribers in the MSC's range (HLR fraction copy).

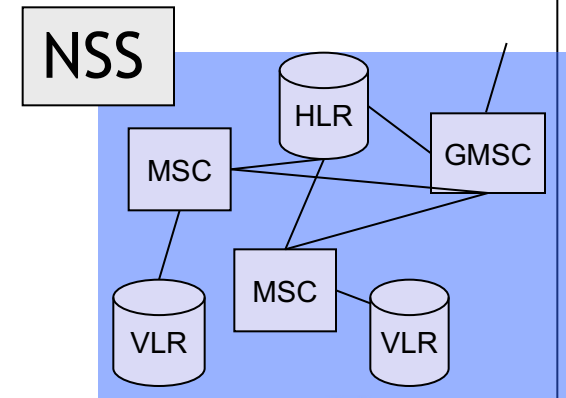

- Transfer of calls or data sessions from one transmitting station (in GSM: Base Transceiver Station, BTS) to another.

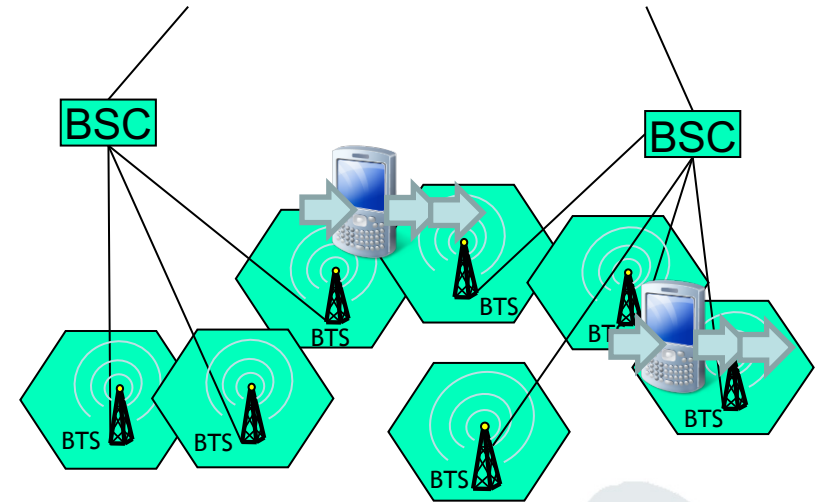

- Term **handover** common in British English
 - In international and Europe based organisations, e.g. ITU-T, IETF, ETSI and 3GPP
- Equivalent term **handoff** in American English
 - In IEEE and ANSI publications

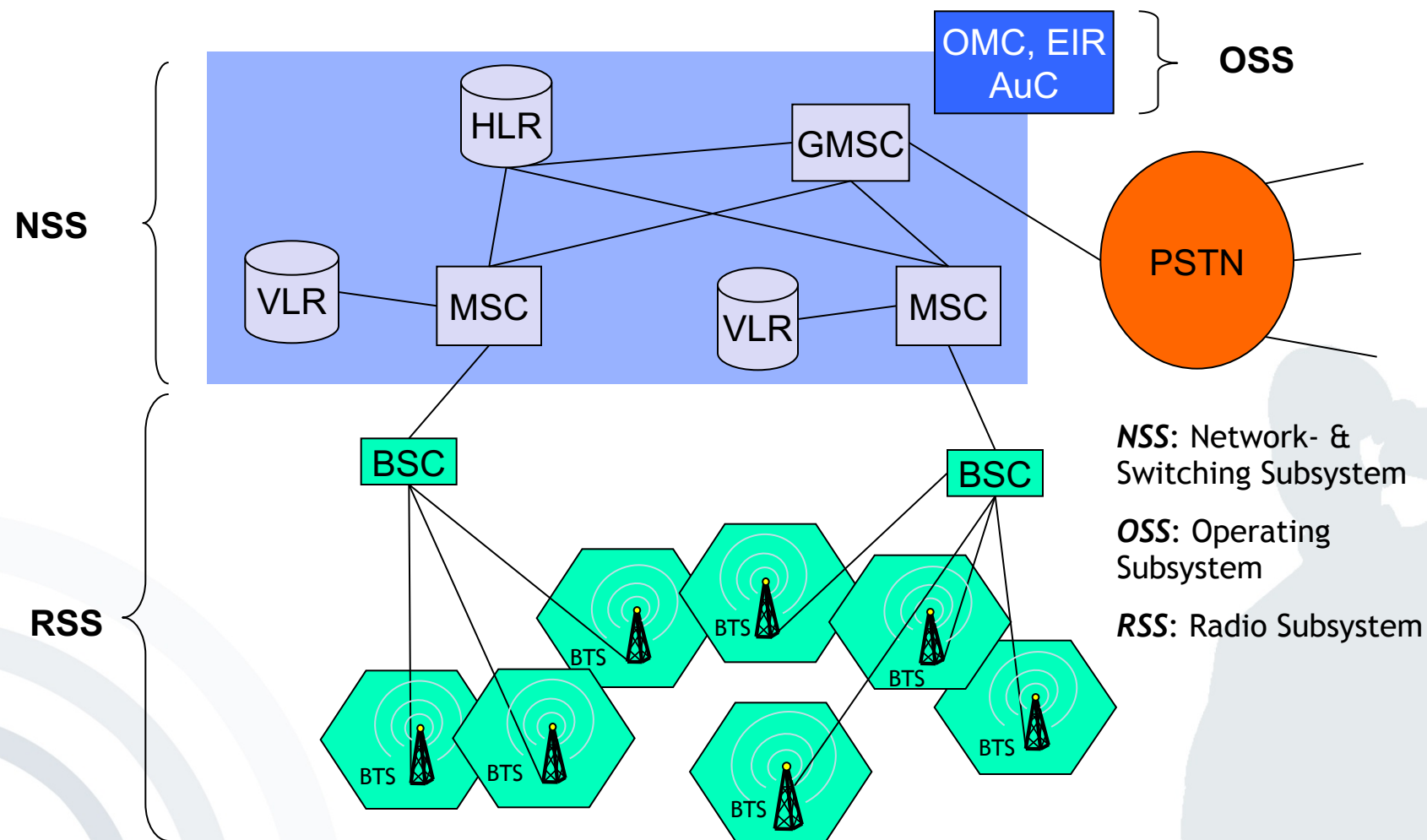

NSS: Network- & Switching Subsystem

OSS: Operating Subsystem

RSS: Radio Subsystem

Data retention of cell-based location data

Tell-all telephone

Green party politician Malte Spitz sued to have German telecoms giant Deutsche Telekom hand over six months of his phone data that he then made available to ZEIT ONLINE. We combined this geolocation data with information relating to his life as a politician, such as Twitter feeds, blog entries and websites, all of which is all freely available on the internet.

By pushing the play button, you will set off on a trip through Malte Spitz's life. The speed controller allows you to adjust how fast you travel, the pause button will let you stop at interesting points. In addition, a calendar at the bottom shows when he was in a particular location and can be used to jump to a specific time period. Each column corresponds to one day.

Monday, 31 August 2009

- Malte Spitz gives a speech to the Greens in Erfurt against internet censorship. (source: [Parteiwebsite](#))
- 6 incoming calls
21 outgoing calls
total time: 1h 16min 8s
- 34 incoming messages
29 outgoing messages
- duration of internet connection: 21h 17min 25s

Speed: 0 to + | 31 Aug 09 12:00 | Show the points in time, Malte Spitz was in the selected map segment, too | Download Data

September | October | November | December | January | February

Data Protection: Betrayed by our own data | Implementation: OpenDataCity © ZEIT ONLINE

[\[www.zeit.de/
datenschutz/
malte-spitz-data-
retention\]](https://www.zeit.de/datenschutz/malte-spitz-data-retention)

- **Operation Subsystem (OSS)**

- Supervises operation and maintenance of the whole GSM network

OSS

OMC, EIR
AuC

- **Components:**

- **Operation and Maintenance Centre (OMC):** Supervises each network component and creates status reports
- **Authentication Centre (AuC):** protects identity of participants & data transmission, administrates keys
- **Equipment Identity Register (EIR):** data base with identification list for devices, e.g. stolen terminals (whitelist, greylist, blacklist)

The GSM system offers different “security services“:

- **Access control and authentication:**
 - Authentication of the subscriber to the SIM by input of a PIN and to the GSM network by challenge-response procedure
- **Confidentiality:**
 - Data & voice transferred between mobile station and BTS are encrypted.
- **(Partial) Anonymity:**
 - No transfer of data which can identify the subscriber via radio, instead temporary identification
 - (Temporary Mobile Subscriber ID, TMSI)

- Challenge-response procedure

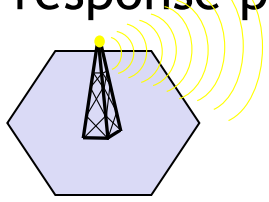

Mobile network



SIM

AuC

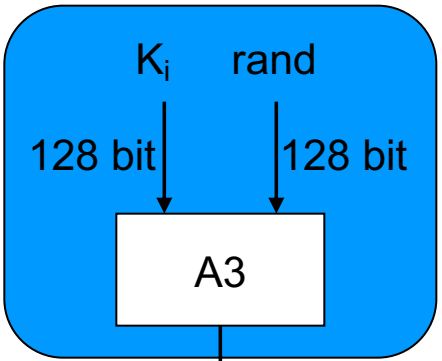

AuC/
NSS

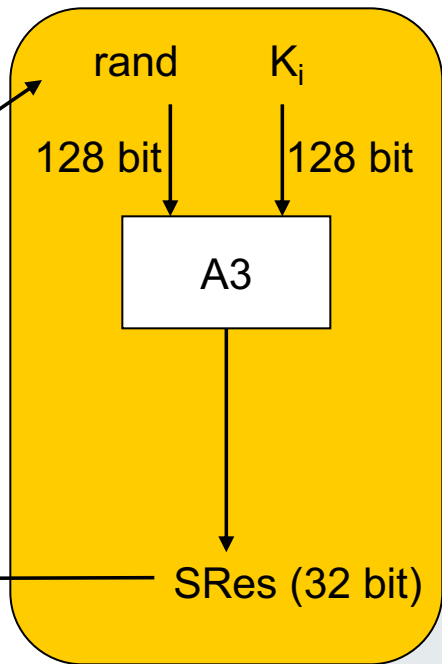
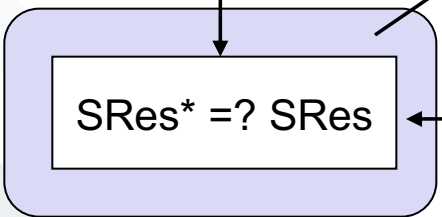

K_i : individual subscriber authentication key
 A3: („secret“) authentication algorithm

SRes: signed response

- Challenge-response procedure (Subscriber Authentication)
Authentication is based on the individual key K_i , the subscriber identification IMSI and a secret algorithm A3.
- K_i and A3 are stored on the SIM and deposited in the AuC.
 1. AuC creates random number *rand*.
 2. AuC encrypts *rand* and K_i via A3 (-> SRes*).
 3. AuC transfers *rand* and SRes* to VLR.
 4. VLR transfers exclusively *rand* to SIM.
 5. SIM computes with “own” K_i and A3 Signed Response SRes.
 6. The SRES computed by the SIM is transmitted to the VLR and is compared with SRES*.
 7. If SRES* and SRES are equal the subscriber is authenticated successfully.

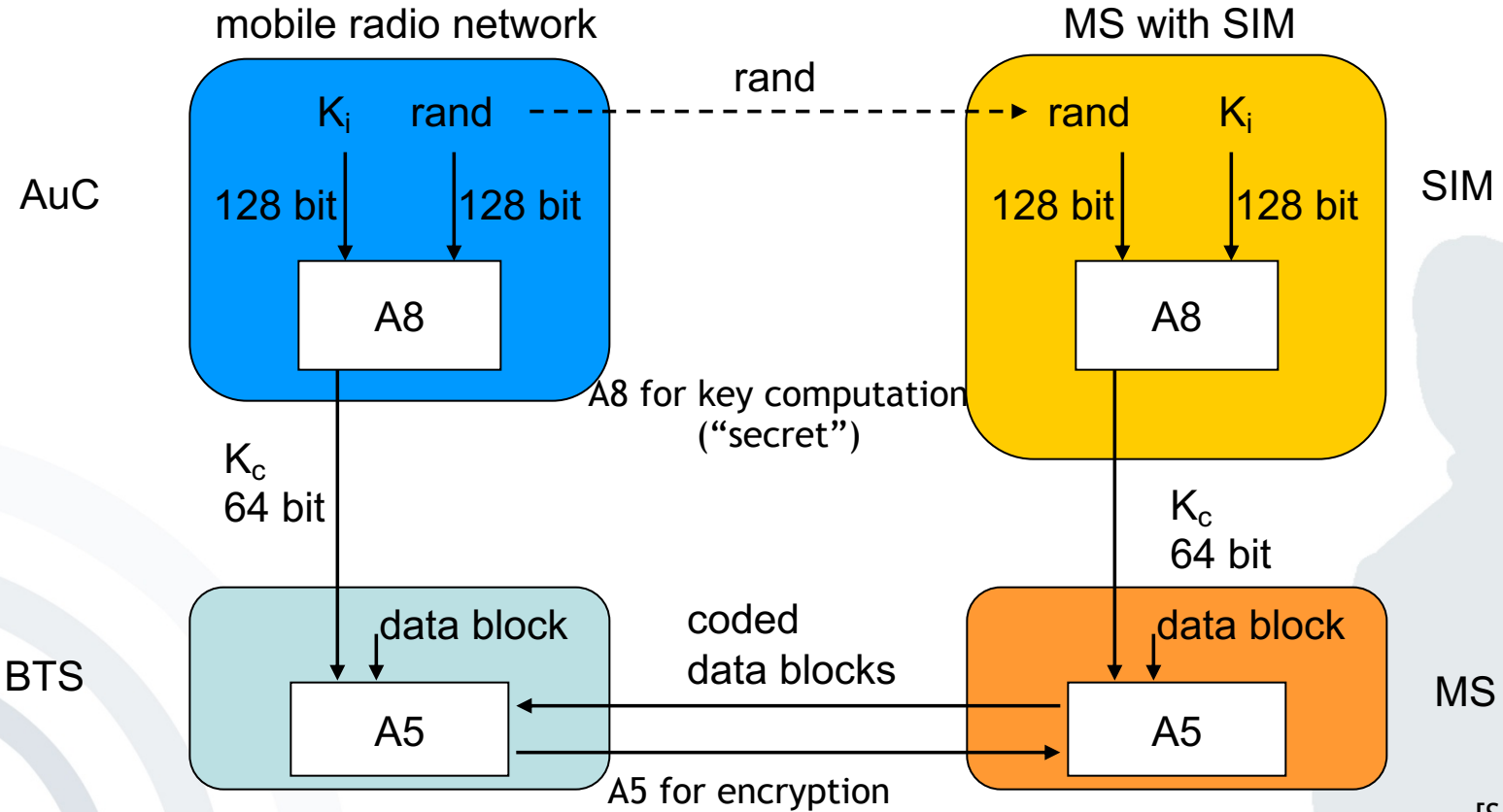
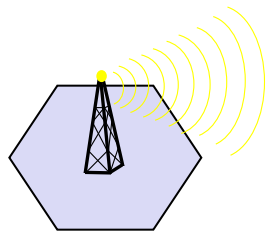

- **GSM provides encryption of voice and data transferred via the air interface:**
 1. AuC creates random number rand.
 2. AuC generates the key K_c for the encryption of the transferred data via rand, K_i and A8.
 3. VLR transfers only rand to SIM.
 4. SIM computes the key K_c using A8, the rand received and the local K_i
 5. Mobile station and mobile radio network use generated K_c and algorithm A5 for encryption and decryption of sent and received data.

- Partial Anonymity:
 - In order to guarantee the anonymity of the users temporary user identification (TMSI) is used.
 - Temporary user identification is updated automatically from time to time or on demand.
 - Data which identify users are not transferred.
 - **Example:** Anonymous charging is (technically) possible via prepaid card.

- Solely authentication of the terminal/subscriber toward the GSM network. The network does not authenticate itself.
 - Assumption that the network is trustworthy per se
 - Security model was developed at a time with a provider monopoly
- Subscriber localization is almost exclusively controlled by the network.
 - Centralized movement tracking is possible
 - In order to avoid localization the subscriber must switch off the terminal.

- Security model bases partly on secret encryption algorithms.
 - A3 and A8 were published without authorization.
 - Some operators use non-standardized algorithms.
- No encryption from terminal to terminal but solely over the air interface
 - Encryption deactivation by the network possible, without notification of the users
- Encryption comparatively “weak” because of key length (64 bit)
 - Sometimes the real key length is shorter.

- Transmission Paradigms
- Cell Based Communication (CBC)
 - Introduction
 - Basic Technology (Cells, Multiplexing)
- Mobile Telecommunication Infrastructures
 - Introduction
 - GSM (Technology, Authentication, Location Management) (2G)
 - UMTS (3G)
 - Long Term Evolution (3.9G, 4G)
 - 5th Generation (5G): mobile broadband
- Roaming

- Universal Mobile Telecommunications System (UMTS):
 - **Status of 2G-Networks:** Different standards in some different continents avoid worldwide roaming
 - **Demand for 3G-Networks:** Globally uniform standard

➔ Voting of regional & national regulation offices (e.g. ETSI, ARIB, ANSI) via the International Telecommunication Union (ITU)



Telekom



Vodafone

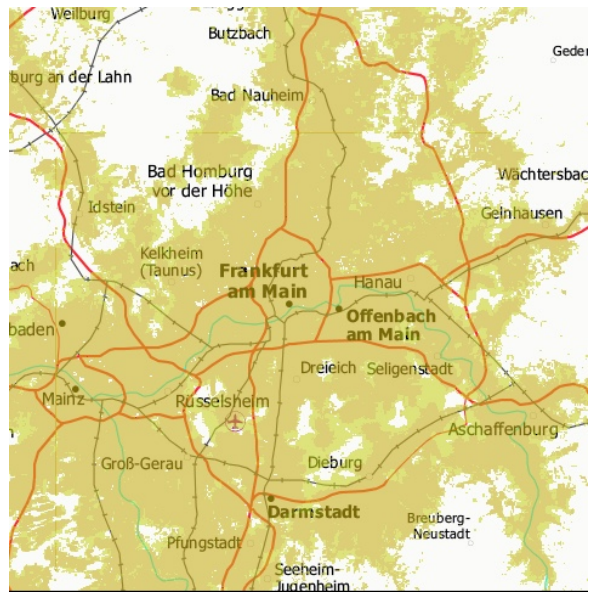

Telefónica

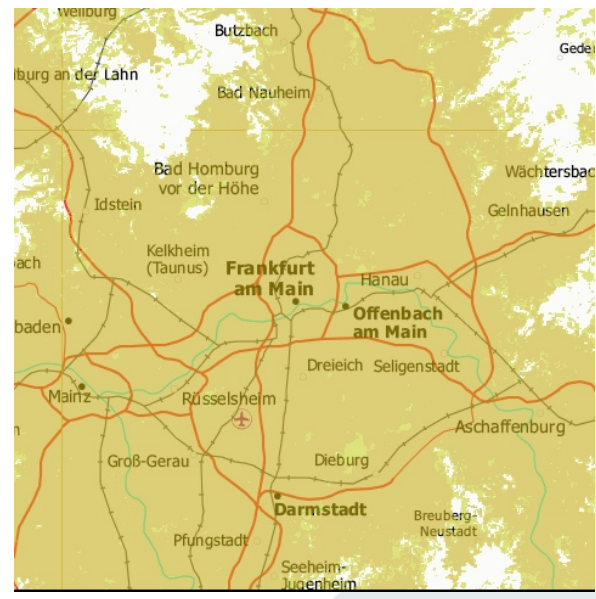

[http://maps.mobileworldlive.com/network_info.php?nid=727&org_id=2076&cid=15]

- **Common approach:**
Worldwide reservation of frequencies in the 2GHz range
- **Problem of competing targets:**
 - Existing national networks and installed network technique shall preferably be transferred into the new standard.
 - ➔ The specification of 3G-Networks, introduced by the ITU, leaves room for national, partly incompatible implementations.
- UMTS (UTRA-FDD/TDD) frequency allocation in Europe:

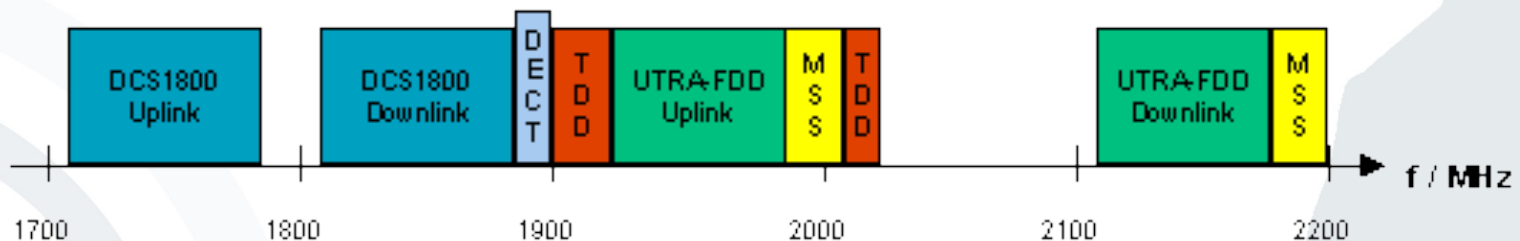

© 2001 UMTSlink.at

UTRA-FDD: UMTS Terrestrial Radio Access - Frequency Division Duplex

[UMTSLink2006]

UMTS (3G) System Architecture

- **UTRAN:**
UMTS
Terrestrial
Radio Access
Network
- **RNS:** Radio
Network
Subsystem
- **RNC:** Radio
Network
Controller
(controls the
Node Bs)
- **Node B:**
UMTS base
stations
(equivalent
to base
transceiver
stations
(BTS) in GSM)

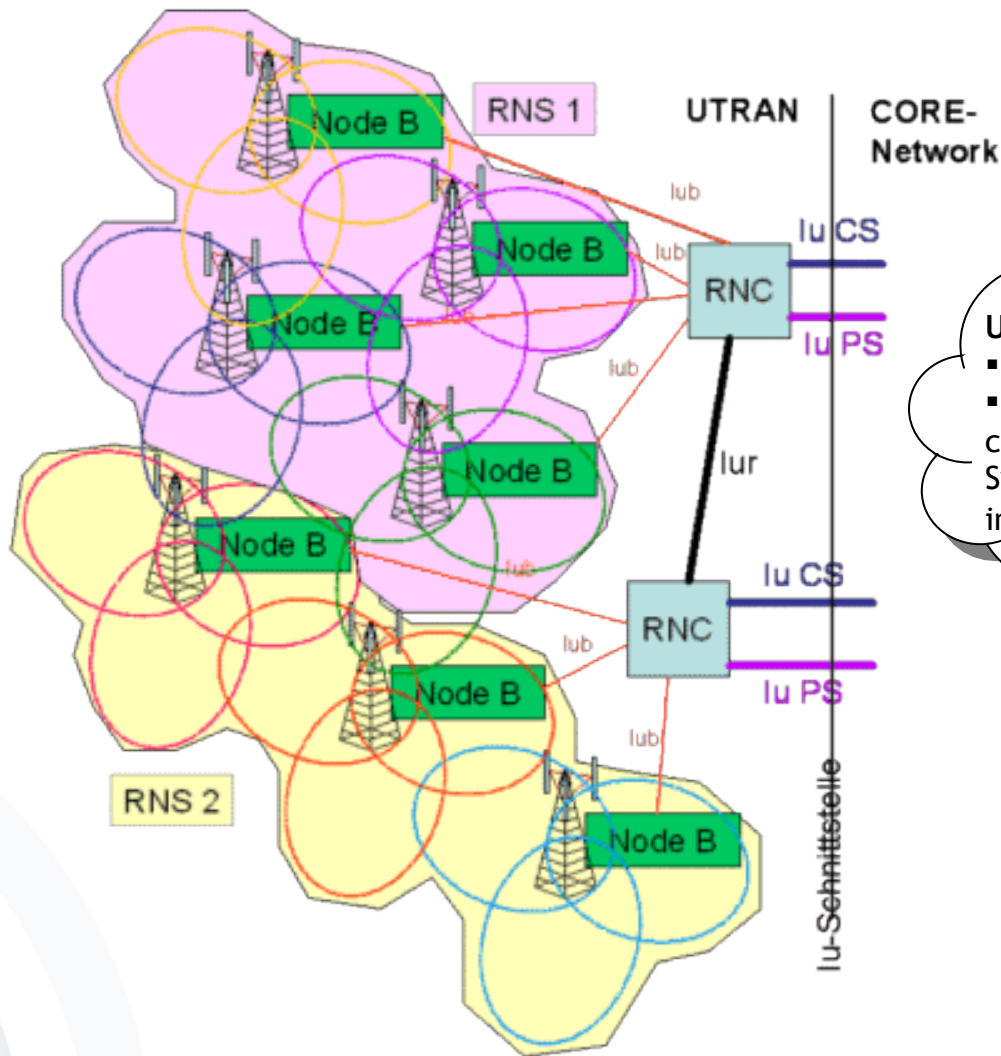

UMTS Core network

- is not shown here in detail
- UMTS Core network corresponds to Network- & Switching Subsystem (NSS) in GSM

- 3G UMTS/HSPA/HSPA+ bandwidths
 - UMTS: 384 kbit/s downlink/uplink
 - High Speed Packet Access (HSPA) provides higher data speeds for downlink and uplink, e.g.
 - 7.2 or 14.0 Mbit/s downlink speed (HSDPA)
 - 1.4 or 5.7 Mbit/s uplink speed (HSUPA).
 - Evolved HSPA (HSPA+) using either *Multiple Input Multiple Output (MIMO)* or *Dual-Cell* technology provides
 - downlink speeds of e.g. 21,1 or 42,2 Mbit/s and
 - a maximum uplink speed of 11.5 Mbit/s.
 - But: Available bandwidth per user decreases if terminal is moving or if there are many participants in one radio cell.
- ➔ Bandwidths enable multimedia services

- UMTS complements the security mechanisms known by GSM:
 - Enhanced participant authentication (EMSI)
 - Network authentication
 - Integrity protection of data traffic
 - Transferred security keys are also encrypted in the fixed network (e.g. HLR-VLR)
 - Increased key length
 - End-to-End encryption is possible.

- The UMTS standard includes the following features:
 - Quality of Service (QoS) for data services
 - Multilateral Security (with regard to authentication)
 - Virtual Home Environment (VHE)
 - High Speed Downlink Packet Access (HSDPA)
 - ...
- However, not all of these features that have been standardised are actually implemented in existing networks, as they are optional and can be added on demand.

- Transmission Paradigms
- Cell Based Communication (CBC)
 - Introduction
 - Basic Technology (Cells, Multiplexing)
- Mobile Telecommunication Infrastructures
 - Introduction
 - GSM (Technology, Authentication, Location Management) (2G)
 - UMTS (3G)
 - Long Term Evolution (3.9G, 4G)
 - 5th Generation (5G): mobile broadband
- Roaming

- **Long Term Evolution (3.9G, “4G”)** standard allows for 300 Mbit/s downlink and 75 Mbit/s uplink speeds
 - First commercial LTE network launched in Scandinavia in December 2009
 - LTE was originally not named a “4G network” due to stricter naming requirements *)
 - The technology can be named either 3.9G or 4G network today.
- **LTE Advanced (4G)** makes use of the frequency spectrum more efficiently, resulting in higher data rates (towards 1 Gbit/s) and lower latency. It remains backward compatible with LTE, uses same frequency bands.



<http://www.3gpp.org/LTE>



<http://www.3gpp.org/LTE-Advanced>

*) A 4G service was originally defined as meeting the *IMT-Advanced* requirements issued by the ITU-R. For more information see [Parkvall2008].

- Transmission Paradigms
- Cell Based Communication (CBC)
 - Introduction
 - Basic Technology (Cells, Multiplexing)
- Mobile Telecommunication Infrastructures
 - Introduction
 - GSM (Technology, Authentication, Location Management) (2G)
 - UMTS (3G)
 - Long Term Evolution (3.9G, 4G)
 - 5th Generation (5G): mobile broadband
- Roaming

Two views of 5G:

- **View 1** - The hyper-connected vision
- **View 2** - Next-generation radio access technology



5G technology promises

- 1 millisecond end-to-end round trip delay (latency)
- 1-10 Gbps connections to end points in the field (i.e. not theoretical maximum)
- 1000 x bandwidth per unit area
- 10-100 x number of connected devices
- 99.999 % availability
- 100 % geographical coverage
- 90 % reduction in network energy usage
- Up to ten year battery life for low power, machine-type devices

- Autonomous driving/Connected cars
- Wireless cloud-based office/Multi-person videoconferencing
- Machine-to-machine connectivity (M2M)
 - vehicle telemetric systems (a field which overlaps with connected cars above)
 - ‘connected home’ systems (e.g. smart meters, smart thermostats, smoke detectors)
 - consumer electronics and healthcare monitoring.
- Virtual Reality/Augmented Reality/Immersive or Tactile Internet

- Transmission Paradigms
- Cell Based Communication (CBC)
 - Introduction
 - Basic Technology (Cells, Multiplexing)
- Mobile Telecommunication Infrastructures
 - Introduction
 - GSM (Technology, Authentication, Location Management) (2G)
 - UMTS (3G)
 - Long Term Evolution (3.9G, 4G)
 - 5th Generation (5G): mobile broadband
- Roaming

- Roaming denotes a change of network access, e.g.:
 - Change of the GSM network operator
 - Change between different network systems (UMTS, GSM, WLAN, CDMA, PDC)
 - Cell change within the GSM system (Handover)
- Roaming usually means extensive changes, e.g. of the network technique or the network operator, and with a new authentication:
 - **Example:** The mobile device automatically logs into an available WLAN when a hotspot is entered (e.g. airport, conferences).

- If a user of a mobile device moves from one cell to another cell, the connection handover should be as smooth as possible.
- GSM manages the handover between radio cells in the range of 100 ms; this implies a short connection interruption.
- The reason for the interruption is, among others, an update of the VLR.

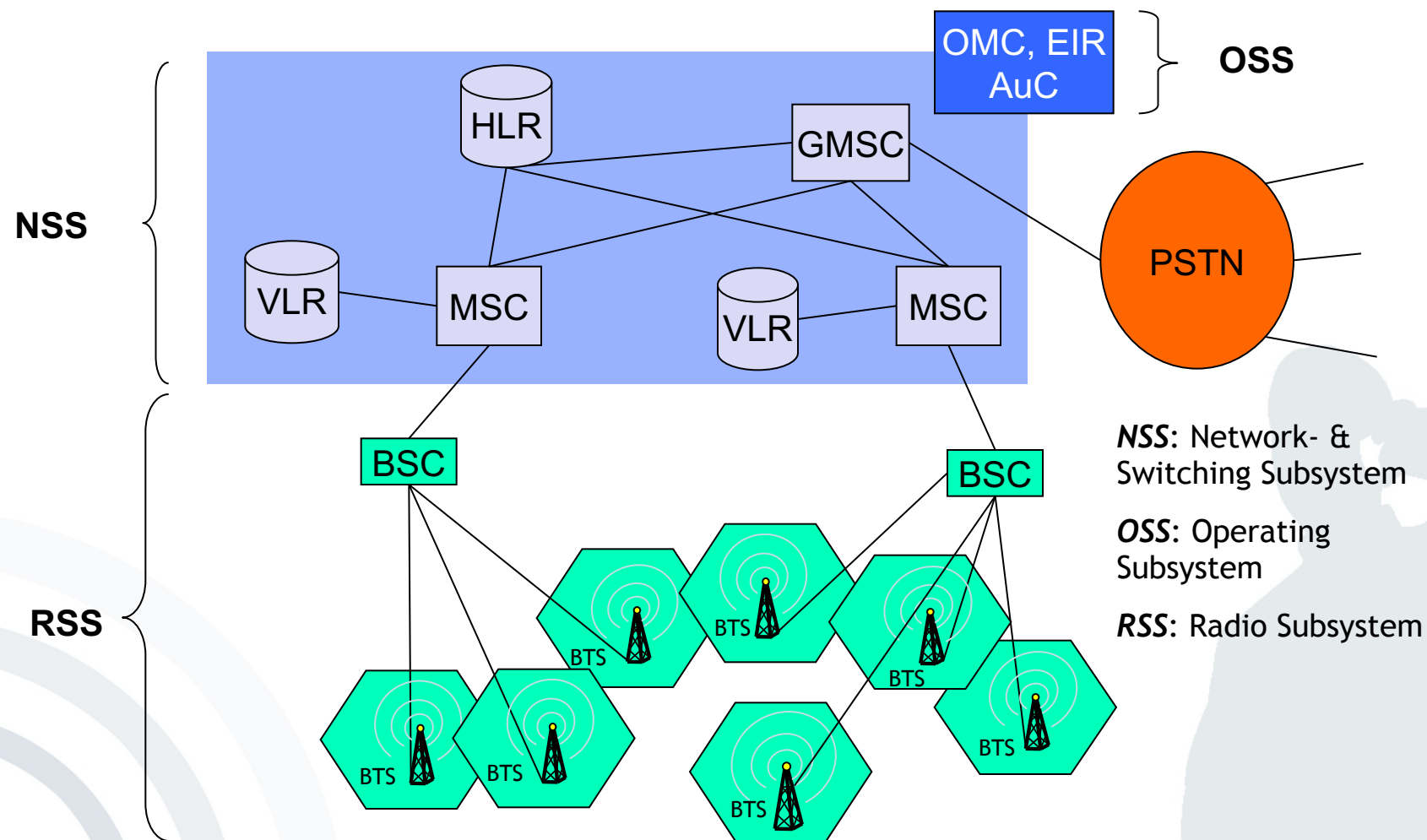

NSS: Network- & Switching Subsystem
OSS: Operating Subsystem
RSS: Radio Subsystem

Based on [Schiller2003]

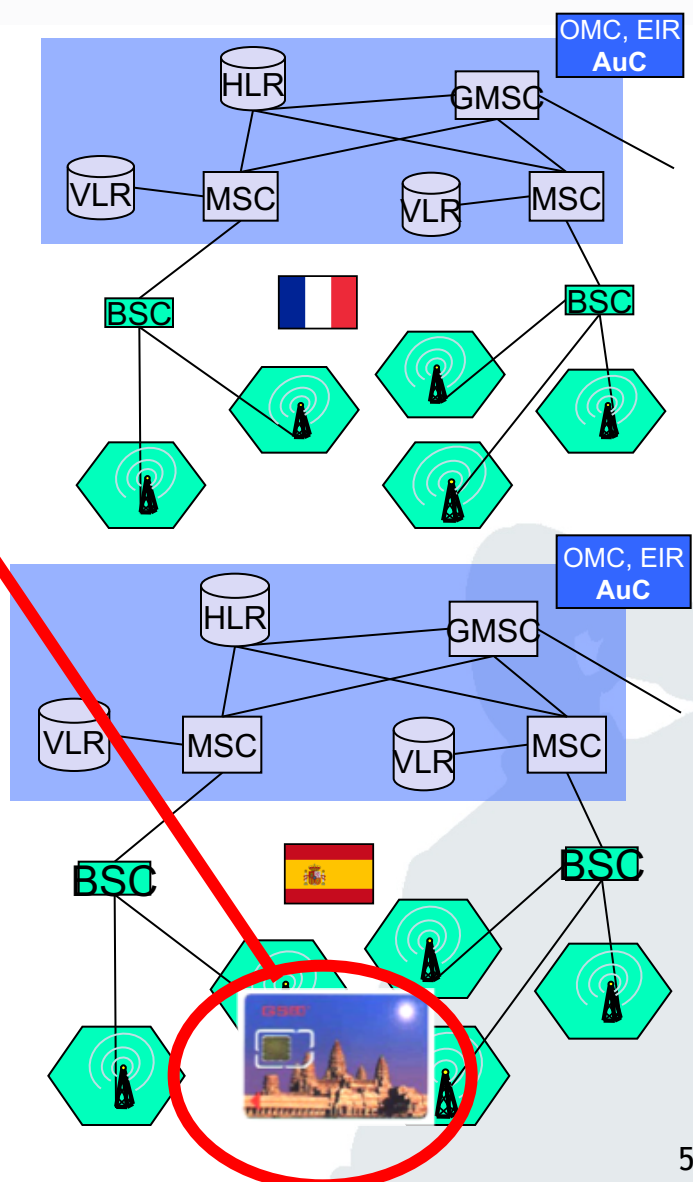
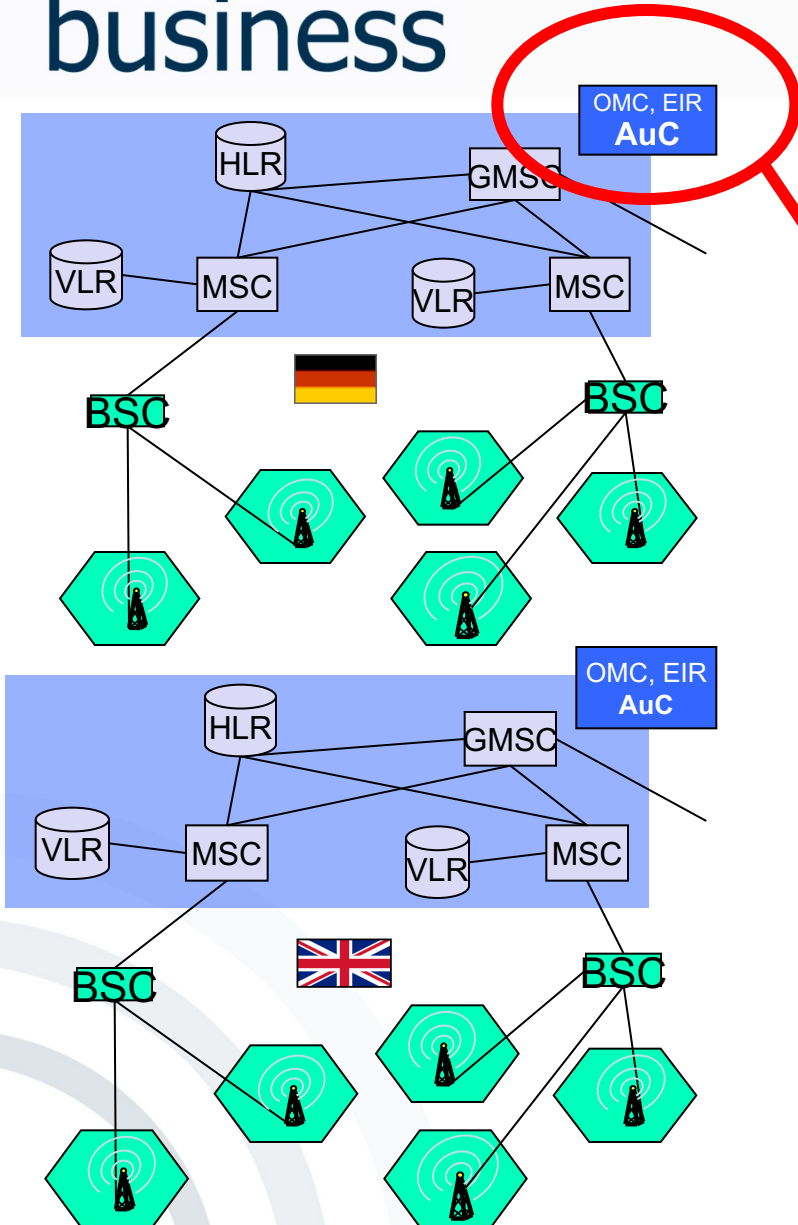

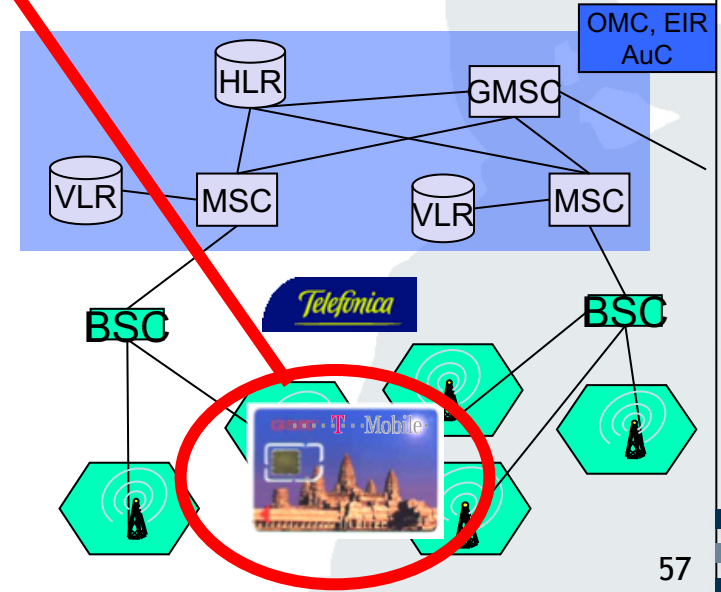
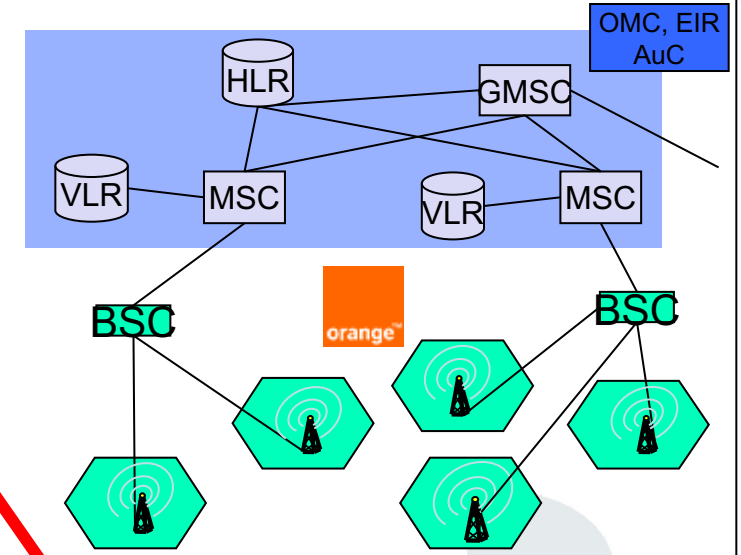
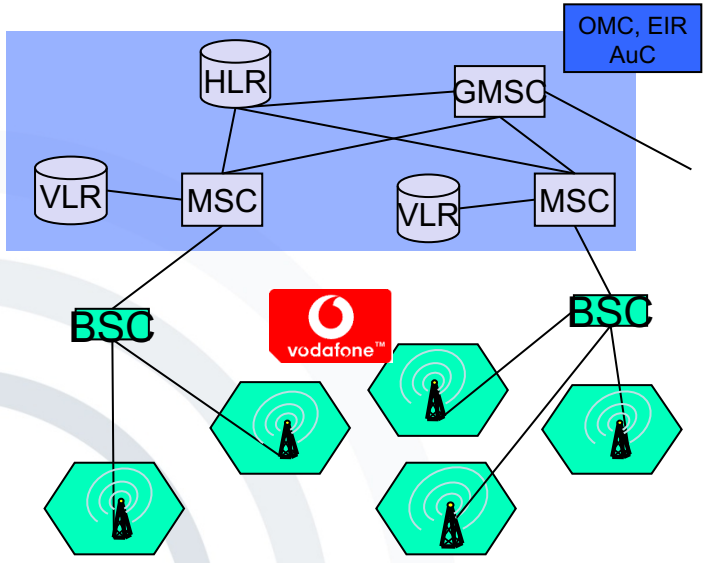
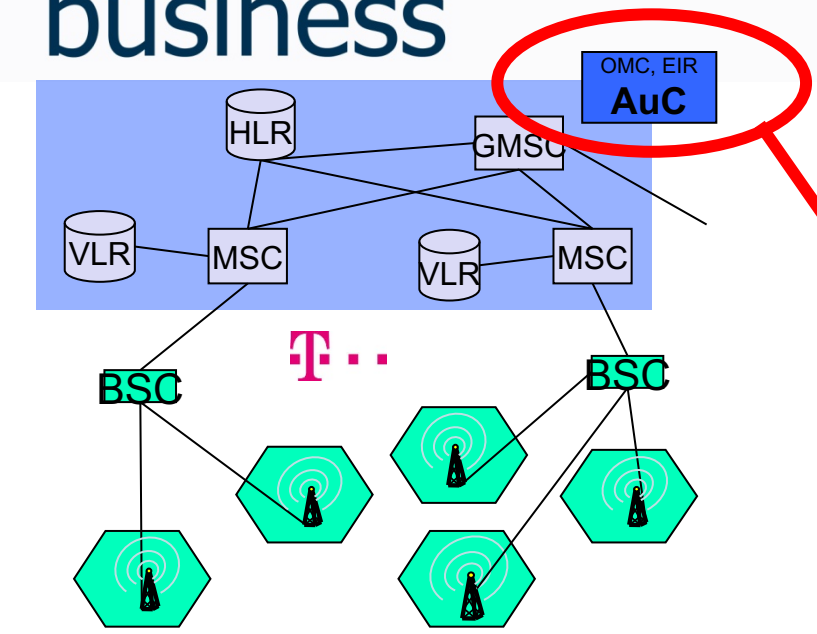

- [BITKOM2005] BITKOM (2005), UMTS Subscribers 2005, www.bitkom.org/de/markt_statistik/38511_38543.aspx, accessed 2006-10-13.
- [GSM2010] GSM Association (2010), GSM Coverage Maps, <http://www.mobileworldlive.com/coverage.asp>, accessed 2010-10-10.
- [GSMA2014] GSM Association (2014), www.gsmamobileeconomy.com, accessed 2014-10-01.
- [GSM2015] GSM Association (2015), GSM Global data, <https://gsmaintelligence.com/>, accessed 2015-09-15.
- [GSM2017] GSM Association (2017), GSM Global data, <https://gsmaintelligence.com/>, accessed 2017-09.
- [GSMA5G] Understanding 5G: Perspectives on future technological advancements in mobile, December 2014, GSM Intelligence <https://gsmaintelligence.com/research/?file=141208-5g.pdf&download>
- [Heise2014] Heise online: Digitale Dividende, <http://www.heise.de/thema/Digitale-Dividende>, accessed 2014-09-03.
- [Parkvall2008] Parkvall, S.; Dahlman, E.; Furuskär, A. - LTE Advanced - Evolving LTE towards IMT-Advanced (PDF). Vehicular Technology Conference Fall 2008, http://www.ericsson.com/res/thecompany/docs/journal_conference_papers/wireless_access/VTC08F_jading.pdf, accessed 2013-10-14.
- [Royer2006] Royer, D. (ed.) (2006): FIDIS Deliverable D11.1, available online at <http://www.fidis.net/resources/deliverables/mobility-and-identity/int-d111000/>

- [Sauter2008] Sauter, M. (2008): Grundkurs Mobile Kommunikationssysteme (3., erweiterte Auflage), Vieweg, Wiesbaden.
- [Schiller2003] Schiller, J. (2003): Mobile Communications, Addison Wesley, London, England.
- [Stat2013] Weltbevölkerung Statista-Dossier 2013, de.statista.com/statistik/studie/id/12358/dokument/weltbevoelkerung-statista-dossier/, accessed 2014-10-01.
- [Stat2014] Entwicklung der Weltbevölkerung von 1950 bis 2010 (in Milliarden), United Nations (Department of Economic and Social Affairs, Population Division) (2014), de.statista.com/statistik/daten/studie/1716/umfrage/entwicklung-der-weltbevoelkerung/, accessed 2014-10-01.
- [Stat2015] Worldometers- world population, <http://www.worldometers.info/world-population/>, accessed 2015-09-15
- [Stat2017] Worldometers- world population, <http://www.worldometers.info/world-population/>, accessed 2017-09
- [StiftWelt2013] Datenreport 2013 der Stiftung Weltbevölkerung - Soziale und demographische Daten weltweit (2013), www.weltbevoelkerung.de/fileadmin/content/PDF/Datenreport_2013_Stiftung_Weltbevoelkerung.pdf, accessed 2014-10-01.
- [StiftWelt2014] Datenreport 2014 der Stiftung Weltbevölkerung - Soziale und demographische Daten weltweit (2014), www.weltbevoelkerung.de/fileadmin/content/PDF/Datenreport_2014_Stiftung_Weltbevoelkerung.pdf, accessed 2014-10-01.
- [UMTSLink2013] UMTSlink, www.umtslink.at, accessed 2013-10-11.